

WL CLASSE BASE CABINET



WL CLASSE BASE CABINET ASSEMBLY MANUAL

INTRODUCTION

Carefully read and follow all instructions to ensure proper and efficient operation of your water purification system. Contact Waterlogic or an authorized Waterlogic distributor if you have any questions.

Waterlogic and an authorized Waterlogic distributor employ trained service personnel who are experienced in the installation, function and repair of Waterlogic equipment.

Waterlogic water purification systems should be combined with selected water treatment components to create a system specifically tailored for each application by trained and qualified personnel.

Products manufactured and marketed by Waterlogic and its affiliates are protected by patents.

Waterlogic International Limited and WLI Trading Limited reserve the right, in order to reflect continuous research and development, to amend or **change specifications without prior notice**. Waterlogic and the Waterlogic logo, Firewall and the Firewall logo are trademarks in countries where the Group operates. WLI Trading Ltd licensed to use BioCote, and BioCote logo which are registered trademarks of BioCote Ltd.

Waterlogic technical manuals cover voltages of both 120v and 220v for all markets where Waterlogic operates. Please ensure that you carefully read the information in this manual and for any parts specific to any market, refer to your technical agreement or specific part listing.

TABLE OF CONTENTS

1. PRECAUTIONS AND GENERAL	3
2. PRODUCT INFORMATION	5
3. INSTALL AND ASSEMBLY.....	7

1. PRECAUTIONS AND GENERAL RECOMMENDATIONS

SAFETY PRECAUTIONS



Ensure all local laws and codes including health and safety guidelines are met when installing this Waterlogic purification system. Only qualified service technicians should attempt installation and service. Always read the entire operating instructions before using the appliance and save these instructions for future use.

Connect to potable water supply: this system is to be used for water only and is not intended for use where water is microbiologically unsafe or with water of unknown quality without adequate disinfection. The system is not intended for treatment of contaminated water.

Installation and maintenance: the installation, maintenance, sanitising and any repair must be performed by qualified persons trained by Waterlogic or their authorized distributors only. Do not remove any panels or covers unless qualified and competent to do so. The detachable hose-sets and the connection kit used to connect the main water are supplied by the technician. Do not reuse connectors.

Indoor use only: Never expose to direct sunlight, heat sources, to freezing temperatures, ambient air temperature above 32°C (86°F) and keep the unit away from excessive humidity.

This appliance is intended to be used in household and similar applications such as: staff kitchen areas in shops, offices and other working environments; farm houses and by clients in hotels, motels and other residential type environments; bed and breakfast type environments; catering and similar non-retail applications.

GROUNDING INSTRUCTIONS: This appliance must be grounded. In the event of a malfunction or breakdown, grounding will reduce the risk of electric shock by providing a path of least resistance for electric current. This appliance is equipped with a cord having an appliance-grounding conductor and a grounding plug. The plug must be plugged into an appropriate outlet that is installed and grounded in accordance with all local codes and ordinances.



WARNING *Improper connection of the appliance-grounding conductor can result in a risk of electric shock. Check with a qualified electrician or service representative if you are in doubt whether the appliance is properly grounded. Do not modify the plug provided with the appliance; if it will not fit the outlet, have a proper outlet installed by a qualified technician*

Use a water pressure regulator: Waterlogic will not be responsible for injury or damage caused by excessive water pressure. Input or feed pressure must be regulated to 3 bar. Be aware of any potential pressure surges caused by building/municipal pumping stations. Water block devices and external leak detectors are strongly recommended.

UV-C emitter (UV lamp): this appliance contains a UV-C emitter (UV Lamp). UV-C radiation may, even in little doses, cause harm to the eyes and skin. Never operate the UV-C emitter if damaged or removed from enclosure. Do not touch or look directly into the faucet. The replacement of the UV-C must be done by Waterlogic or approved Waterlogic distributors and with power supply disconnected. The UV lamp must be replaced at 6 month intervals or when necessary.

Do not operate if damaged: If the machine or supply cord is damaged, it must be replaced by the manufacturer, its service agent or similarly qualified persons in order to avoid a hazard.

This appliance contains a UV-C emitter: Unintended use of the appliance or damage to the housing may result in the escape of dangerous UV-C radiation. UV-C radiation may, even in little doses, cause harm to the eyes and skin. Appliances that are obviously damaged must not be operated. Replacement of the UV-C emitter cannot be conducted by the user, please contact Waterlogic for assistance or help finding an Authorized Service Representative. Read the maintenance instructions before opening the appliance. The appliance must be disconnected from the supply before replacing the UV-C emitter.



WARNING: Do not operate the UV-C emitter when it is removed from the appliance enclosure.

Electrical installation: For an appliance provided with a cord and intended for installation under a counter or in a cabinet, the following must be followed;

- The electrical power socket shall be installed in a cabinet or on a wall adjacent to the undercounter space in which the appliance is to be installed
- There shall be an opening through the partition between the compartments specified in (a) that is large enough for the attachment plug to pass through. The longest dimension of the opening shall not be more than 1-1/2 in (38 mm);
- The edges of the opening shall, if the partition is wood, be smooth and rounded, or, if the partition is metal, be covered with an edge protector provided for this purpose by the manufacturer
- Care shall be exercised, when the appliance is installed or removed, to reduce the likelihood of damage to the supply cord
- The appliance is to only be used with the power supply provided with the appliance.

Electrical shock hazard: Always use a dedicated and properly earthed outlet. Unit should be protected by residual current device (RCD) having a rated residual operating current not exceeding 30 mA. Use only Waterlogic supplied power cord. Never use extension cords or power strips to connect unit. Do not use if the supply cord is damaged, it must be replaced by the service agent or a similarly qualified person in order to avoid a hazard.

EN: This appliance can be used by children aged from 8 years and above and persons with reduced physical, sensory or mental capabilities or lack of experience and knowledge if they have been given supervision or instruction concerning use of the appliance in a safe way and understand the hazards involved. Children shall not play with the appliance. Cleaning and user maintenance shall not be made by children without supervision.

IEC: This appliance is not intended for use by persons (including children) with reduced physical, sensory or mental capabilities, or lack of experience and knowledge, unless they have been given supervision or instruction concerning use of the appliance by a person responsible for their safety. Children should be supervised to ensure that they do not play with the appliance.





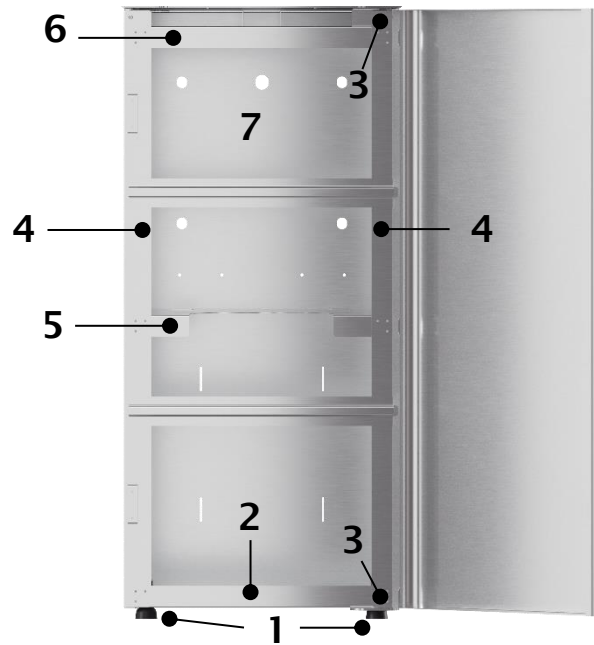

The instructions for an ultraviolet radiation appliance shall contain the manufacturer's declaration of conformity to the applicable provisions of the Code of Federal Regulations (CFR) requirements including, Title 21, Chapter 1, Subchapter J, Radiological Health

2. PRODUCT INFORMATION

WL CLASSE BASE CABINET

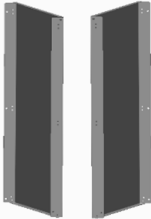
2.1 CONTENTS

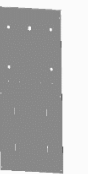

Item N°	Image	Description
1		Rubber Feet
2		Down Panel
3		Bottom Hinge/Top Hinge
4		Side panel (L/R)
5		Middle Shelf
6		Top Shelf
7		Back Panel
8		Front Panel

2.2 TECHNICAL INFORMATION



TECHNICAL DATA

CLASSE BASE CABINET

Physical

Dimensions (W x D x H) [mm]

400mm(W) X 590mm(D) X 824mm(H)

Weight (net) [kg]

4.2kg

3. INSTALL AND ASSEMBLY

3.1 ASSEMBLY



Ensure all local laws and codes including health and safety guidelines are met when installing this Waterlogic purification system. Only qualified service technicians should attempt installation and service. Always read the entire operating instructions before using the appliance and save these instructions for future use.

1. Carefully unbox and remove the base cabinet parts from its packaging. Ensure there are no trip hazards while you do this. Locate the down panel (Item 2, page 5) and the rubber feet (Item 1, page 5). You will need to fit a rubber foot to each corner of the down panel. Then locate the bottom hinge (item 3, page 5) and screw to the front, left hand side of the down panel as per below image.

Note: If your ClassE unit came with caster wheels and they were installed on the unit, they must be removed for the unit to seat properly onto the base cabinet. Those wheels may be transferred to the base cabinet if desired for easier mobility. Removing and reinstalling the caster wheels onto the base cabinet will require the use of a 14mm thin-profile wrench pictured below.



Rubber Feet

Caster Wheels

Thin-Profile
Wrench - 14mm



2. Lay the down panel flat on its rubber feet (or Caster Wheels) with the bottom hinge facing towards you on the right-hand side. Locate the left-hand panel (item 4, page 5) and screw to the down panel as per below image;

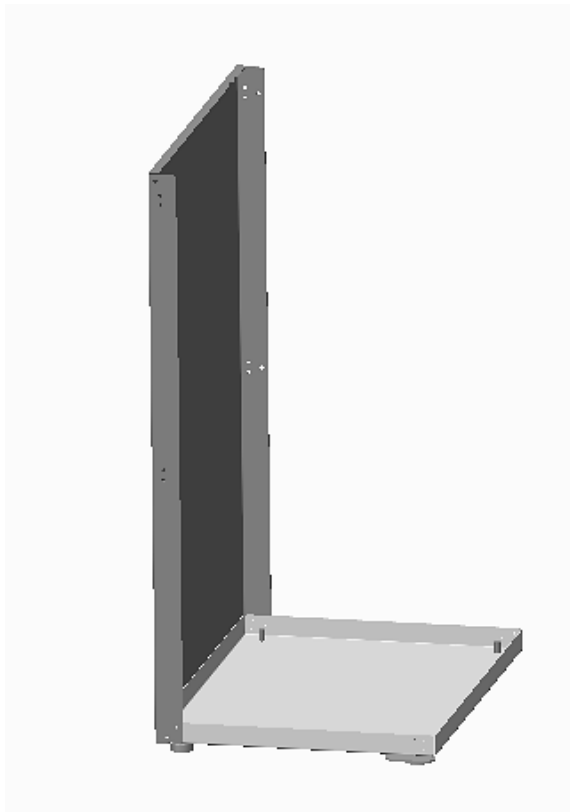

3. Locate the middle and top shelf (items 5 and 6 from page 5) and carefully screw each shelf to the left-hand panel, gently support the shelf as you screw the shelf to the left-hand panel.

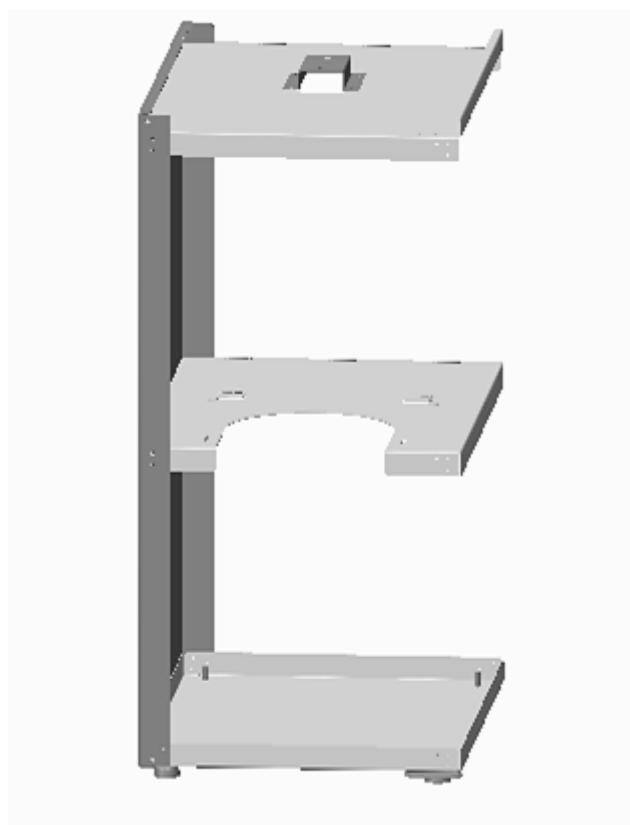

4. The base cabinet now has its core supports with the shelving. Locate the right-hand side panel (Item 4, page5) and screw the right-hand panel to the down panel, middle shelf and top shelf.

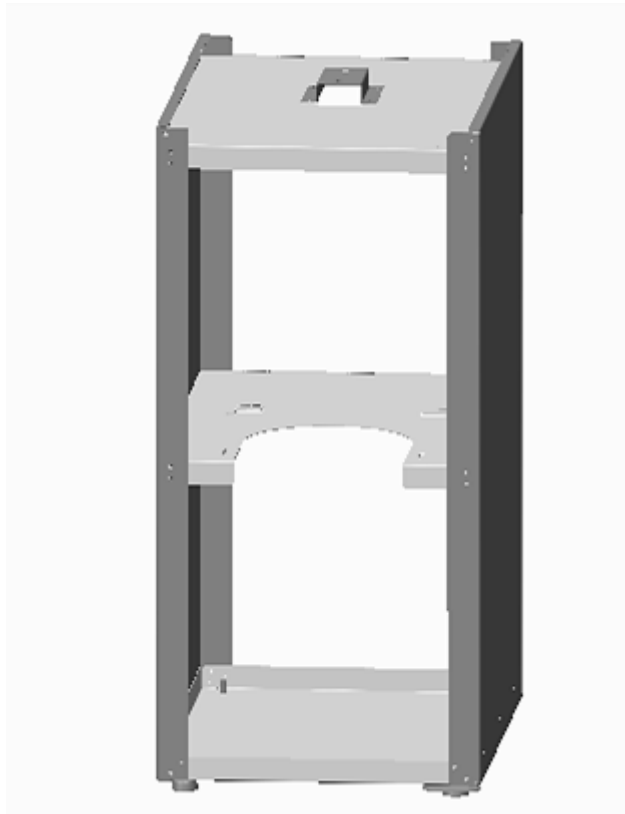

5. Locate the rear panel (item 7, page 5) for the base cabinet. It may be easier to lay the base cabinet on its front, carefully screw the back panel to the rear of the base cabinet as per the below image;

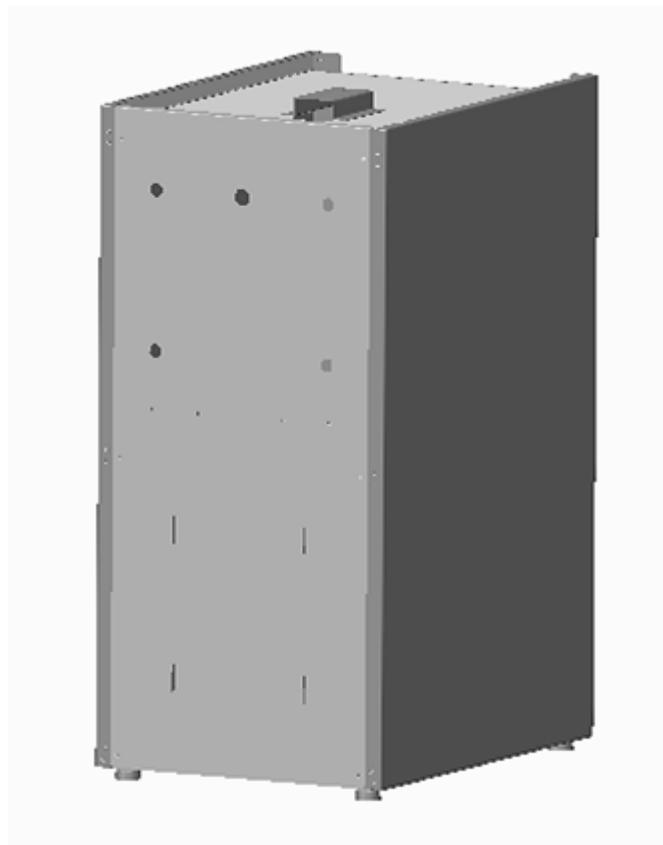

6. The base cabinet should now feel sturdy and solid. The front panel (item 8, page 5) now needs to be fitted to the base cabinet. To do this, carefully slot the front panel into the bottom hinge (item 3, page 5) and rest the top panel against the base cabinet. Locate the top hinge and slot this into the top panel. Screw the top hinge to the base cabinet and ensure the door opens and closes freely.

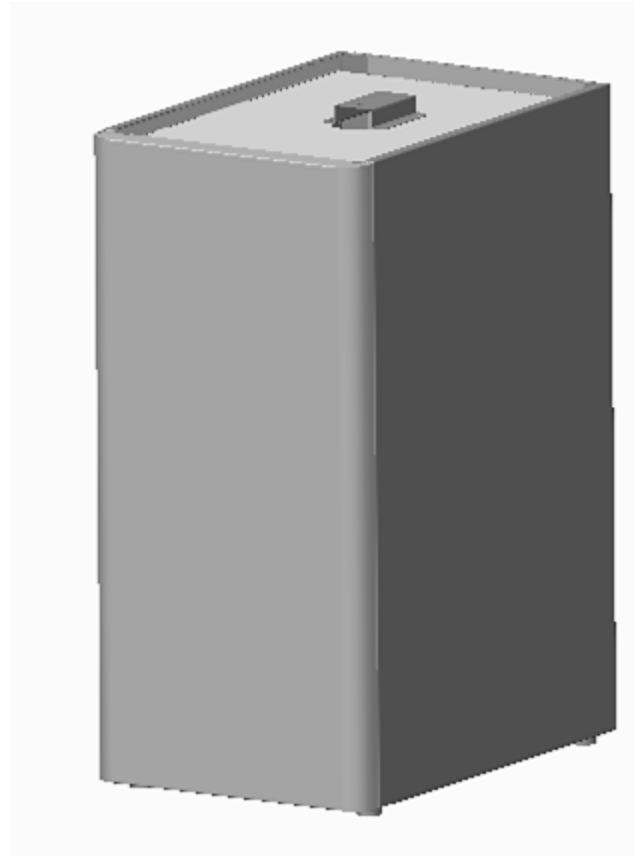

7. Carefully clean all the panels of the base cabinet ensuring any hand or finger marks have been removed. It is recommended to use S11 Aquadosa spray to ensure all bacteria has been removed from the base cabinet.





Waterlogic Trading Ltd

+353 1 293 1960

WLI Trading Limited Second floor, Suite 4,
Beacon Court, Sandyford, Co. Dublin, Ireland

WLI (UK) LTD

info@waterlogic.ie

Waterlogic International LTD Global
Headquarter 1 Grenfell Road,
Maidenhead, Berkshire, SL6 1HN,
United Kingdom

For technical support Email: support@waterlogicsupport.zendesk.com