

WL290 DRAWINGS AND PARTS LISTS

Yellow = Consumables

Green = Recommended
spare parts

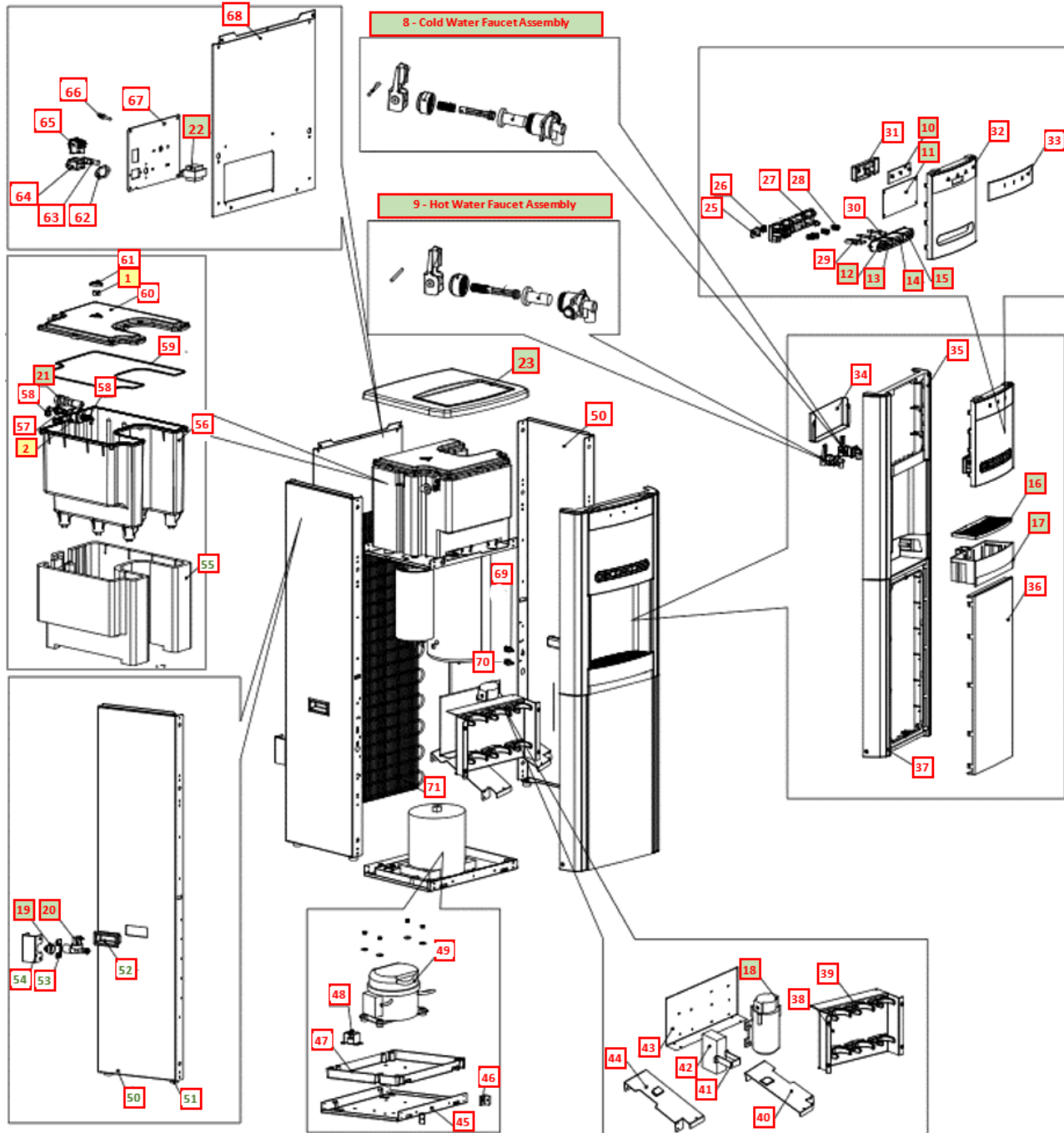

WL290 DRAWINGS AND PARTS LISTS







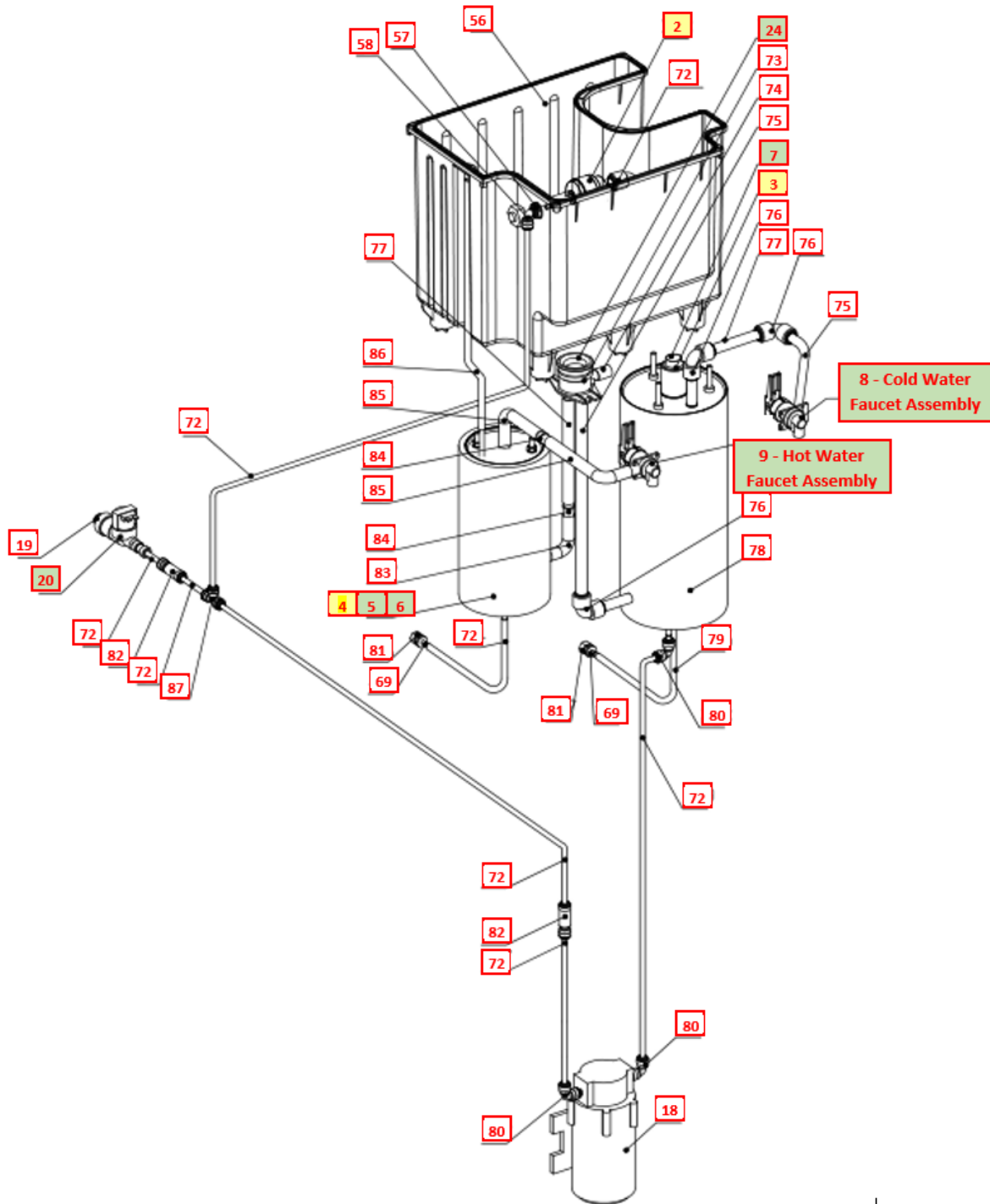



Wetted Drawing

Yellow = Consumables

Green = Recommended spare parts



No	WLCP Part Number	Description	Factory Part Number	Stocked?	
Consumables					
1	19-1052	Carbon Air Filter	PU-4108	Yes	
2	AK-0005-L00-00	Small Inline GAC Filter	AK-0005-L00-00	Yes	
3	10-2350	8W UV Lamp Assembly with Starter	CT-2083	Yes	
4	HT-0010-I00-00	Hot Tank with Sensor <i>Replace every 3-5 years depending on usage</i>	HT-0010-I00-00	Yes	
Not Shown	FT-0035	GAC Filter - 10" Carbon Activated Inline Filter – Optional *Element is P/N FT-0038	FT-0035-IL-WLT	Yes	
Not Shown	FT-0063	Carbon Block - 10" CBC 1 Micron Lead and Cyst Reduction Inline Filter – Optional *Element is P/N FT-0064	FT-0063-IL-WLT	Yes	
Not Shown	FT-0053	Sediment Filter - 10" Sediment 20 Micron Inline Filter – Optional *Element is P/N FT-0055	FT-0053-IL-WLT	Yes	
Not Shown	01-2076	Scale Kleen	NA	Yes	
Recommended Spare Parts					
5	12-1360	Hot Tank Overload Devices (High Safety Limit). - 105°C (221°F) <i>Recommend stocking 1 each per every 10 units purchased</i>	HT-3012	Yes	
6	12-6900	Hot Tank Overload Devices (High Safety Limit). Metal Cover <i>Recommend stocking 1 each per every 10 units purchased</i>	ST-8289	Yes	

7.1	10-1400	Quartz Sleeve for 8W Lamp <i>Recommend stocking 1 each per every 10 units purchased</i>	CT-2002	Yes	
7.2	10-2500	Black O-Ring for Quartz sleeve <i>Recommend stocking 1 each per every 10 units purchased</i>	CT-2006	Yes	
8	19-1051	Cold Water Faucet Assembly <i>Recommend stocking 1 each per every 10 units purchased</i>	PL-1260-E	Yes	
9	19-1050	Hot Water Faucet Assembly <i>Recommend stocking 1 each per every 10 units purchased</i>	NA	Yes	
8.1 9.1	19-1063	Faucet Silicon Stopper <i>Recommend stocking 1 each per every 10 units purchased</i>	PU-4117	Yes	
10	EN-0046-L00-00	Display PCB <i>Recommend stocking 1 each per every 10 units purchased</i>	EN-0046-L00-00	Yes	
11	EN-0045-L00-00	Main PCB <i>Recommend stocking 1 each per every 10 units purchased</i>	EN-0045-L00-00	Yes	
12	19-1043	Hot Water Safety Push <u>Button</u> (Left) <i>Recommend stocking 1 each per every 10 units purchased</i>	PL-1265-L00-BK	Yes	
	LP-0425-L00-00	Hot Water Safety Mechanical Dispense <u>Sticker</u> <i>Recommend stocking 2 each for every 10 units purchased</i>	LP-0425-L00-00	Yes	
13	19-1040	Hot Water Push <u>Button</u> <i>Recommend stocking 1 each per every 10 units purchased</i>	PL-1262-L00-BK	Yes	
	LP-0423-L00-00	Red Mechanical Dispense <u>Sticker</u> – for Hot (Right) <i>Recommend stocking 2 each for every 10 units purchased</i>	LP-0423-L00-00	Yes	
14	19-1041	Middle <u>Button</u> <i>Recommend stocking 1 each per every 10 units purchased</i>	PL-1264-L00-BK	Yes	

	LP-0429-L00-00	Clear Middle Button <u>Sticker</u> <i>Recommend stocking 2 each for every 10 units purchased</i>	LP-0429-L00-00	Yes	
15	19-1042	Cold Water Push <u>Button</u> <i>Recommend stocking 1 each per every 10 units purchased</i>	PL-1263-L00-BL	Yes	
	LP-0430-L00-00	Blue Mechanical Dispense <u>Sticker</u> - for Cold <i>Recommend stocking 2 each for every 10 units purchased</i>	LP-0430-L00-00	Yes	
16	19-2015	Drip Tray Grill <i>Recommend stocking 2 each per every 10 units purchased</i>	PL-1270-C	Yes	
17	19-2020	Drip Tray Body <i>Recommend stocking 2 each per every 10 units purchased</i>	PL-1289-B	Yes	
18	CT-0021-L00-00	Self-Suction Pump <i>Recommend stocking 1 each per every 10 units purchased</i>	CT-0021-L00-00	Yes	
19	Purchase from John Guest	Inlet Solenoid Valve JG Adaptor 1/4 (CI320816S) <i>Recommend stocking 1 each per every 10 units purchased</i>	PU-4104-DP	Purchase from John Guest	
20	19-1001	Inlet Solenoid Valve 120V <i>Recommend stocking 1 each per every 10 units purchased</i>	PU-4096	Yes	
21	19-1004	Water Level Controller with Wire <i>Recommend stocking 1 each per every 10 units purchased</i>	PU-4100	Yes	
22	EL-5006-A CN	UV Lamp Ballast 110V/60Hz <i>Recommend stocking 1 each per every 10 units purchased</i>	10-3010	Yes	
23	19-5005	Black Top Cover <i>Recommend stocking 1 each per every 10 units purchased</i>	PL-1254	Yes	
24	19-1057	Silicon Seal for Inlet Port to Tanks <i>Recommend stocking 1 each per every 10 units purchased</i>	PU-4109	Yes	

Remainder of parts					
25	19-1045	Hot Safety Push Button Safety Lock	PL-1267	Yes	
26	NA	Hot Water Safety Lock Spring	CST-8327	No	
27	19-1047	Faucet Bracket	PL-1269	Yes	
28	NA	Faucet Push Pin Spring	CST-8326	No	
29	19-1044	Hot Water Safety Button Pin	PL-1266	Yes	
30	19-1046	Faucet Push Pin	PL-1268	Yes	
31	NA	Display PCB Cover	PL-1347	No	
32	NA	Front Hatch Panel	PL-0147-L00-00	No	
33	NA	LED Label	LP-0335-L00-00	No	
34	NA	Main Printed Circuit Board (PCB) Cover	ST-0143-L00-00	No	
35	19-1034	Top Front Panel for Drip Tray <i>*Request to be shipped with Hot Water Safety Sticker P/JN LP-7169 WLCP PN 12-1001.</i>	PL-1255	Yes	
35.1	12-0001	Hot Water Safety Sticker	LP-7169	Yes	
36	19-5015	Lower Front Insert Panel	PL-1149-A	Yes	
37	19-1035	Bottom Panel	PL-1256	Yes	

38	NA	Filter Bracket	ST-0145-L00-00	No	
39.1	10-3099	2 ½" Filter Clip	PU-4024	Yes	
39.2	10-3098	2" Filter Clip	PU-4025	Yes	
40	NA	Rail Bracket – Right	ST-0172-L00-00	No	
41	NA	Adaptor Bracket	ST-8315	No	
42	NA	Power Adaptor	EL-0126-L00-00	No	
43	NA	Pump Bracket	ST-0173-L00-00	No	
44	NA	Rail Bracket – Left	ST-0171-L00-00	No	
45	NA	Bottom Base	ST-0174-L00-00	No	
46	19-1021	Side Panel Bracket	ST-8229	Yes	
47	NA	Leak Tray	PL-0149-L00-00	No	
48	19-1025	Level Sensor Bracket	ST-8232	Yes	
49	NA	Compressor 120V	CO-0011-L00-00	No	

50	19-1019	Side Panel	ST-8212	Yes	
51	10-3083	Rubber Feet	ST-8016	Yes	
52	12-8058	Side Panel Plastic Handle	PL-1123	Yes	
53	19-1020	Inlet Solenoid Valve Bracket	ST-8214	Yes	
54	19-1026	Inlet Solenoid Valve Cover	ST-8233	Yes	
55	NA	Reservoir Thermal Insulation	PL-0090-L00-BL	No	
56	19-1037	3 Gallon Plastic Reservoir	PL-1258	Yes	
57	10-3067	Bulkhead Union 1/4" x 1/4" John Guest P/N PI1208S	PU-4028-A	Yes	
58	Purchase from John Guest	JG Stem Elbow Connector 1/4" * 1/4" - Acetal PI220808S)	PU-4066-A	No	
59	19-1056	Reservoir Cover Silicon Seal	PU-4099	Yes	
60	19-1038	Reservoir Cover	PL-1259	Yes	
61	19-1076	Air Filter Silicon Cap	PL-1290	Yes	
62	19-1015	Gasket for Power Socket	ST-8052	Yes	
63	10-3014	Fuse Holder and Fuse 120V / 15A with One Wire	EL-5053	Yes	

64	19-1090	Power Line Noise Filter, ElectroMagnetic Interference filter (EMI)	EL-5029	Yes	
65	10-3008	Red Compressor and Heater Switch	EL-5004	Yes	
66	NA	Switch and Wire to Filter Reset Timer	EL-0131-L00-00	No	
67	NA	Access Metal Cover	ST-0181-L00-00	No	
68	19-1017	Back Panel	ST-8210	Yes	
69	14-5011	Drain Valve Body for 5/16" *14-5011 includes Drain Valve Body and Cap *See #81	CT-2031-A	Yes	
70	NA	Drain Valve Nut for 1/4" and 5/16"	CT-2082	No	
71	NA	Wire Condenser	CO-0009-L00-00	No	
71.1	12-1001	Filter Dryer	CO-9008	Yes	
72	Purchase from John Guest	JG LLD PE Tube - Blue O.D.1/4"John Guest P/N PE-08-BI-1000F-B	PU-4031-A	No	
73	19-1039	Water Inlet to Port to Tanks	PL-1261	Yes	
74	NA	Silicon Stopper Cap Blocks Ambient Port	PU-4117	No	
75	19-1099	1/2" Pipe White Tubing - John Guest PN PE-16-GI-0250F-W	PU-4126-KR	Yes	

76	Purchase from John Guest	JG 1/2" Elbow fitting (PP0316W)	PU-4141-KR	No	
77	NA	HK silicone 1/2" pipe (natural)	PU-4126-B	No	
78	NA	Cold Tank with Thermistor	CT-0013-L00-00	No	
78.1	10-2650	Cold Thermistor - Sensor	CT-2081	Yes	
79	10-3062	JG LLDPE Tube - Blue 8mm John Guest P/N PE-0806-100M-B	PU-4014-A	Yes	
80	NA	JG Equal Elbow Connector 1/4" (PI0308S)	PU-4008	Purchase from John Guest	
81	14-5011	Drain Valve Cap for 5/16" – 1/4" *14-5011 includes Drain Valve Body and Cap - See #69	CT-2028	Yes	
82	12-5690	JG Non-Return Valve 1/4"(1/4SCV)	PU-4057	Yes	
83	19-1058	Silicon Elbow Tube Pipe 25*40	PU-4110	Yes	
84	NA	Silicon Pipe Straight Connector	PU-4101	Yes	
85	19-1060	Silicon Pipe 48.5*155 Elbow	PU-4112	Yes	
86	NA	Silicon Pipe 5/16"	PU-4064-L00-00	No	
87	Purchase from John Guest	JG Equal Tee Connector 1/4" (PI0208S)	PU-4011-A	No	
Not Shown	10-3007	Power Cord 120V – 1840 mm	EL-5001-B	Yes	