

SERVICE REQUIREMENTS

⚠ WARNING! *Read and understand the contents of this manual before attempting to service WL100 Water Treatment System. Failure to follow the instructions in this manual could result in death, serious personal injury, or severe property damage. Only trained and qualified technicians should attempt to install, maintain, or service Waterlogic Equipment.*

1. Visually inspect all electrical and water connections for signs of wear or damage.

⚠ DANGER! **HIGH VOLTAGE ELECTRICAL HAZARD.** *Unplug before inspection and service.*

2. Ensure there is adequate (minimum of 5 cm – 2 inches) clearance around the unit and clean the Condenser Grill and Compressor fan to provide efficient cooling system operation.
3. Sanitize the Cold Tank per instructions in the pre-installation procedures.
4. Clean and sanitize external surfaces of the unit. Use soap and water or chemicals that are compatible with ABS plastic and will not damage or degrade the product surfaces.
5. Remove and clean the Faucet. Replace as needed.

⚠ WARNING! **SANITIZER MAY CONTAIN HAZARDOUS CHEMICALS.** *Use of proper personal protective equipment such as rubber gloves and eye protection is required.*

HOT TANK PRINCIPLES OF OPERATION

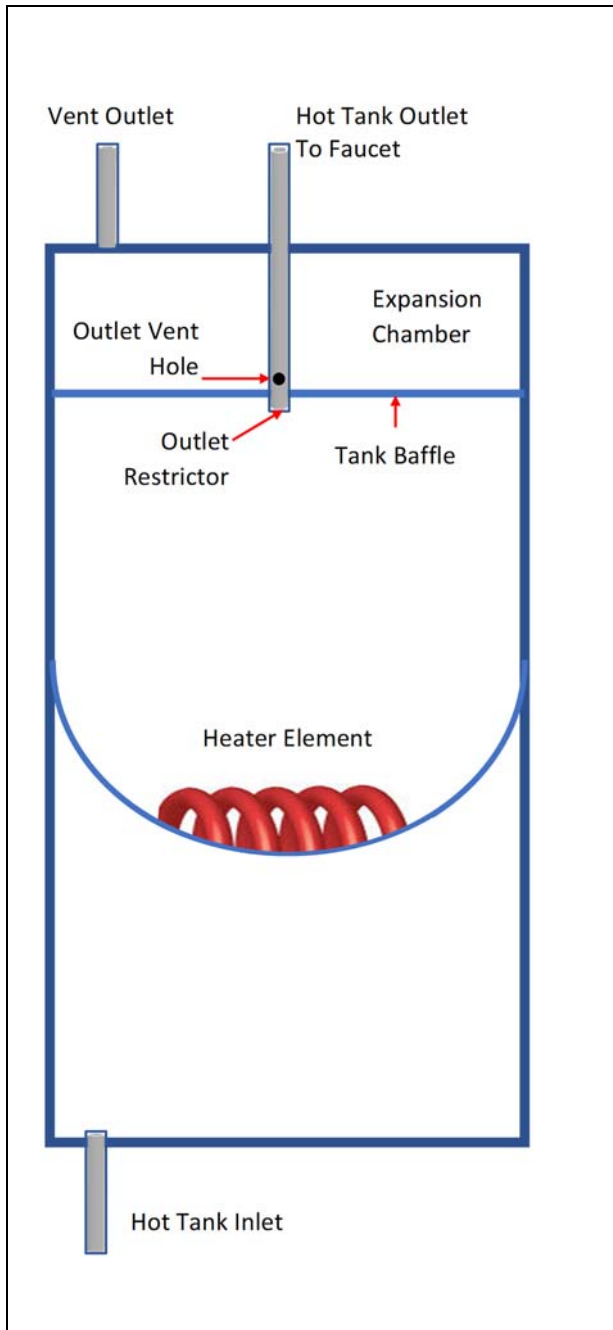

All **Waterlogic** Hot Tanks have a built in Vent or Expansion Chamber in the top of the tank except for WL270 (GF) units.

The Vent Chamber allows for expansion of the water when it is heated.

The chambers are separated by a welded-in tank baffle.

Water always flows into the bottom of the tank and out the top to the faucet.

The Hot Tank outlet tube has a restrictor in its base. This ensures the reservoir is always full by allowing more water in than out.

There is a small hole in the side of the tank outlet tube that allows air and water to pass into the vent chamber as it is heated.

Water in the vent chamber is suctioned back through the outlet tube vent hole when water is dispensed.

Expansion of water as it is heated in the reservoir will push the water out the faucet when the outlet tube vent hole becomes plugged with debris or scale.

The small Outlet Vent Hole is susceptible to scale build up and is a key indicator that descaling is required.



It is critical to descale the Hot Tank through the vent line and outlet line on a regular basis to prevent this problem.



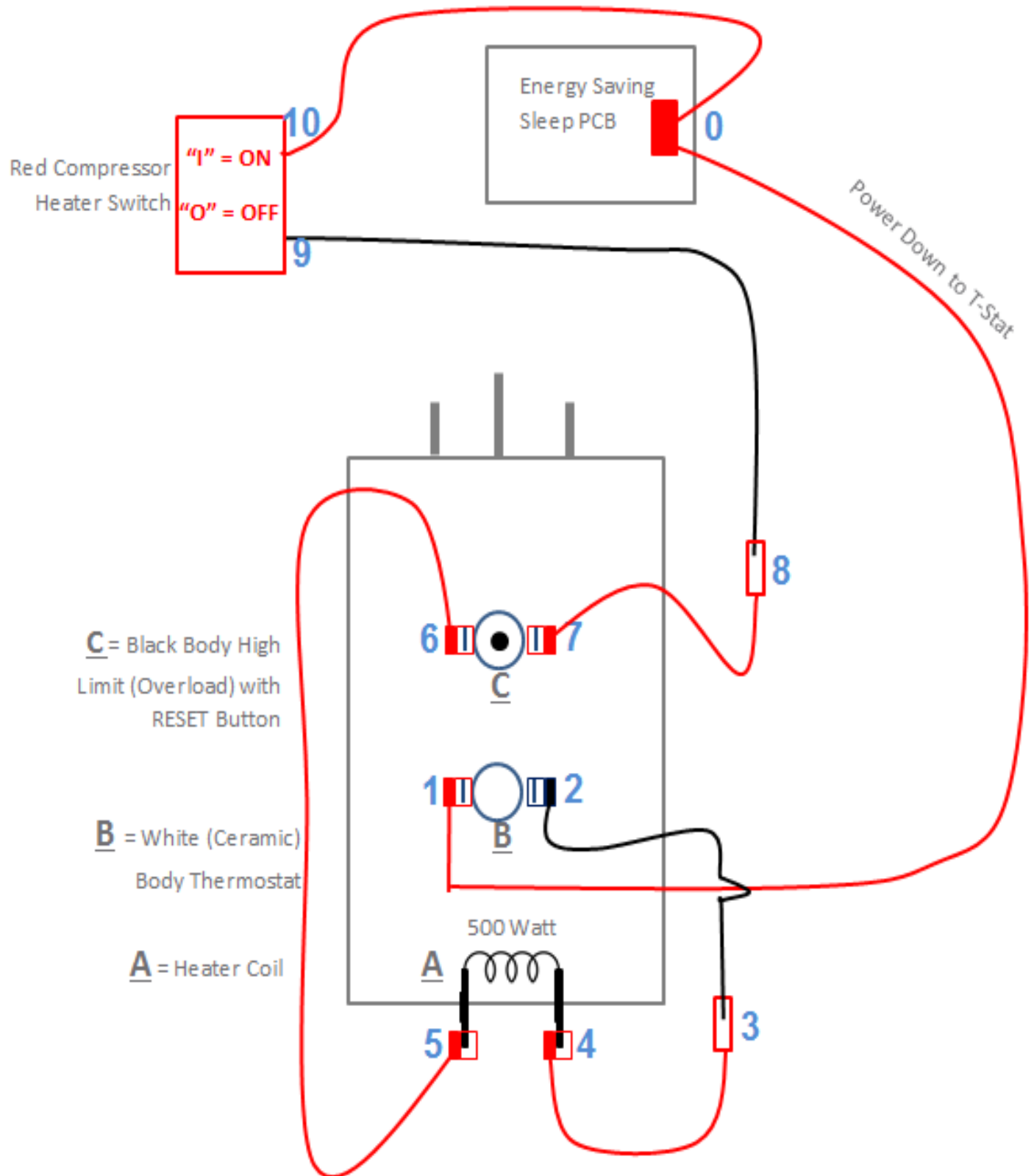

Descaling through the inlet and/or outlet lines only will not clean the vent chamber and outlet vent hole properly.

HEATER CIRCUIT

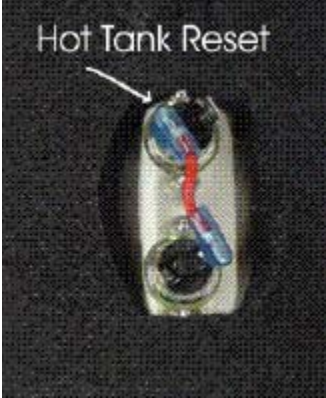

RESETTING THE HOT TANK OVERLOAD OR HIGH LIMIT SAFETY

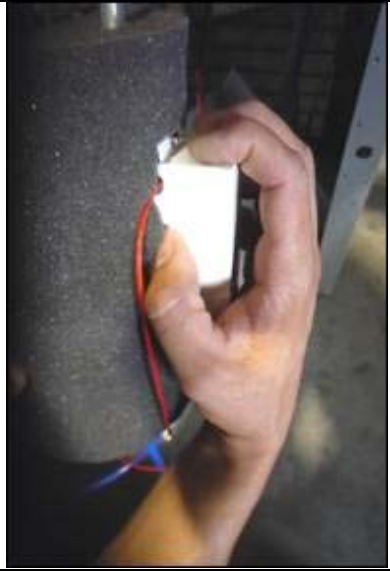
1.	Red Compressor/Heater Switch must be in the <i>O=OFF</i> position	
2.	Unplug the Power Cord from rear of unit.	
3.	Remove the Lower Front Panel of unit by removing the Phillips head screws underneath the Lower Front Panel.	
4.	Locate the Protective Metal Box on the rear of the Hot Tank. As you look through the condenser coils on the rear of the unit, you will see the Hot Tank located on the right-hand side.	
5.	<p>From the Front of the Water Treatment System, reach up behind the Hot Tank and take hold of the protective metal box covering the thermostat and overload on the Hot Tank.</p> <p>There are nuts that secure the Protective Metal Box to the Hot Tank, are loose enough to allow you to remove the Protective Metal Box.</p> <p>If the nuts on the metal box are too tight, loosen the nuts securing the Hot Tank to the Upper Base of the WL100 Water Treatment System unit and lower the Hot Tank so you can remove the Protective Metal Box.</p>	

<p>6.</p>	<p><i>For demonstrative purposes, photos below have lowered the Hot Tank from the unit.</i></p> <p>Press the reset button</p>	 
<p>7.</p>	<p>Reattach the Protective Metal Box by depressing the top flap of the Protective Metal Box so it snaps back into its original position on the Hot Tank.</p>	
<p>8.</p>	<p>Replace the Lower Front Panel.</p>	
<p>9.</p>	<p>Plug in the Power Cord.</p>	
<p>10.</p>	<p>Turn on the Red Compressor/Heater Switch <i>I=ON</i> position</p> <p>The Hot and Cold Tanks must be filled with water BEFORE turning on the Red Heater and Compressor Switch.</p>	
<p>11.</p>	<p>Verify the WL10 Water Treatment System is fully operational before installing it at the customers' site.</p>	

HOT TANK DESCALING INSTRUCTIONS

The hot tank requires removal of mineral deposits (descaling) on a regular basis depending upon local water conditions. Descaling should take place every 6 to 12 months to preserve long-term reliability when source water has high mineral content or high TDS. Descaling removes calcium deposits, or scale, that can build up inside a tank over time. Scale is non-toxic but left unattended will hinder your unit's performance and result in a drip to the faucet as water expands in the hot tank while heating. Excess scale results in higher energy consumption and may cause premature failure of the hot tank. It is critical to descale the entire hot tank including the expansion or vent chamber to ensure proper operation. A random drip of hot water out the faucet is key indication the expansion chamber is not functioning properly, and descaling may be needed.

Use non-toxic cleaner such as ScaleKleen, DEZCAL, 20% Citric Acid Solution, or Vinegar Solution to remove mineral deposits as directed by the manufacturer.

⚠ WARNING! **PERSONAL PROTECTIVE EQUIPMENT REQUIRED.** *Always ensure proper ventilation and use rubber or nitrile gloves and eye protection when using chemicals. Refer to Material Safety Data Sheet for specific requirements of each product.*

⚠ CAUTION! **STAINLESS STEEL TANK DESCALING.**
The Hot Tank is made from stainless steel. Ensure descaling solution is compatible with stainless and always flush the unit completely. Dispose in an environmentally safe manner.

Materials Needed:

- Personal Protective Equipment. Rubber or Nitrile Safety Gloves and Protective Eyewear
 - Phillips Screwdriver, Temperature Gauge
 - Water Pitcher or Container to collect water dispensed from the faucet
 - 20 Liter (5 gallon) container or a drain basin
 - Citric Acid Based Descaler or Vinegar
 - ¼" Plastic Tubing, at least 4 feet in length, and assorted ¼" quick connect fittings
 - Inline Sanitizing Cartridge (Waterlogic Filter Sump without cartridge works well)
 - Food Coloring – FDA safe and biodegradable recommended.
1. Bypass Filters before starting the Descaling Procedure.
 2. Put descaler per directions and 3 drops of food coloring into the descaling cartridge.
 3. Connect Descaling Cartridge to the inlet water supply and connect to Inlet Bulkhead Fitting on the back of **WL100 Water Treatment System**. Turn on Water Supply.
 4. Select Hot Water and depress the Main Dispensing Button on the Front Control Panel until descaling solution (colored water) comes out of the Faucet. Container and drain basin will be required to catch water from the faucet.
 5. Turn off water supply and remove Sanitizing Cartridge from inlet water supply. Reconnect water supply to Inlet Fitting.

6. Allow descaling solution to remain in the Hot Tank for 15 minutes (length of time may vary depending on water conditions).
7. Place a pitcher, catch basin or other container under the faucet of the **WL100 Water Treatment System**.
8. Flush the Hot Tank until water runs clear.
9. Once clear Water dispenses from the Faucet, the Hot Tank has been descaled. Always ensure unit is performing to the customer's satisfaction.
10. Replace Filters.

 **WARNING! HOT WATER. Unit produces Hot Water up to 87°C (189°F). Water above 52°C (125°F) can cause severe burns or scalding. Hot water should be dispensed carefully into insulated container to avoid injury.**

 **CAUTION! MUST REPLACE HOT TANK EVERY 3-5 YEARS DEPENDING ON USAGE. The Hot Tank and its controls must be replaced a minimum of every 3-5 years depending on usage to ensure efficient and dependable operation.**

 **WARNING! REINSTALL ALL PANELS AND COVERS. Always reinstall all Panels, Protective Covers, and Fasteners after servicing equipment. Failure to do so could result in severe personal injury and will void the certifications and warranty of the equipment.**

ADJUSTING COLD SET POINT

Cold Water Temperature – Factory Set Point is 41°F (5°C) and can be adjusted to 34°F - 54°F (1.1°C to 12.2°C)

The cold set point can be adjusted by accessing the cold thermostat adjustment screw under the decal at the rear of the unit.



Remove the red portion of the Cold Tank Temperature label to access the adjustment screw.

The factory set point is ~41°F and is indicated by the dot on sheet metal.



Turning the adjustment screw clockwise to lower the set point temperature.

Do not adjust past the “Max Cold” position at 3:00 position to avoid freezing the cold tank.



Turning the adjustment screw counter-clockwise to raise the set point temperature.

PROGRAMMING “DISABLING ENERGY SAVING SLEEP MODE”

All **WL100 Water Treatment Systems** come from the factory with Energy Saving Sleep Mode engaged to meet the Energy Star Certification requirements. Energy Star Sleep Mode disables the Heater Circuit if the hot dispense has not been used for 3 hours.

Selecting any button "wakes up" the **WL100 Water Treatment System** and turns the Heater circuit back on. The Hot Tank will typically take less than 10 minutes to heat the water from ambient to the 85°C (185°F) set point.

Unplug Power Cord and remove Top Cover to access Energy Saver PCB.

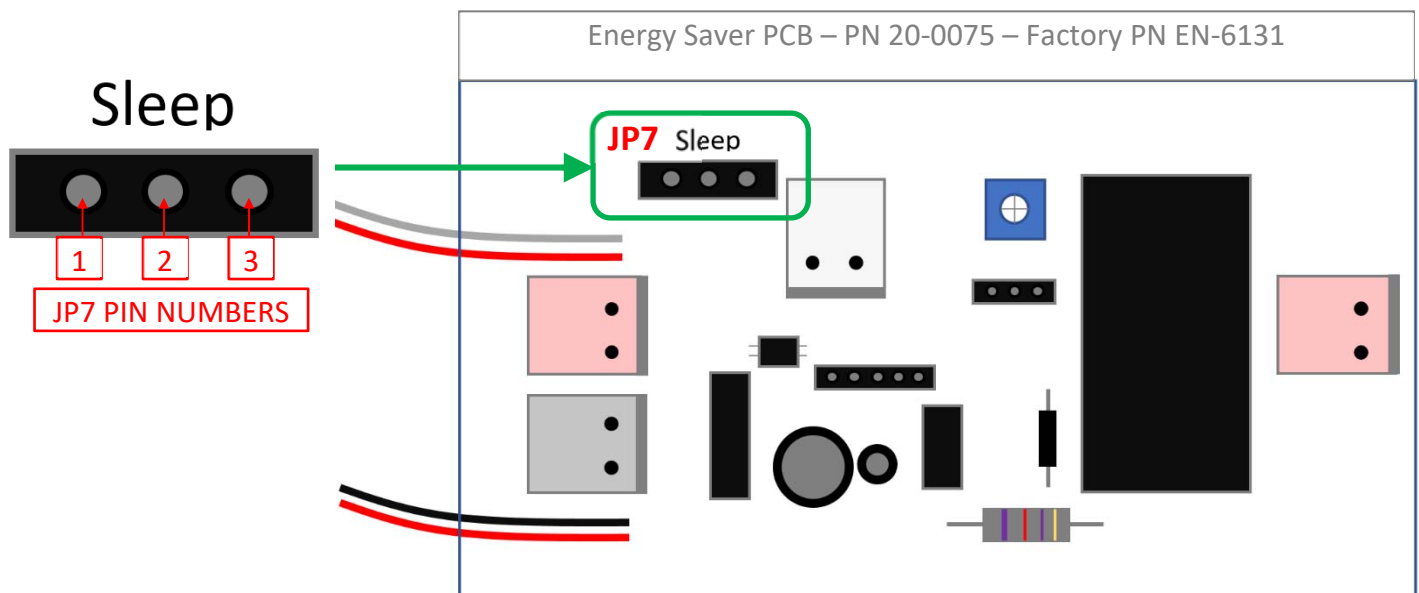

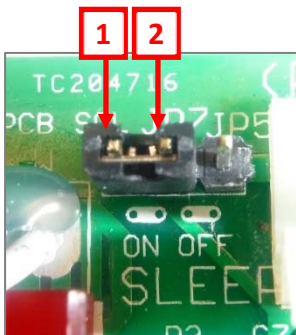
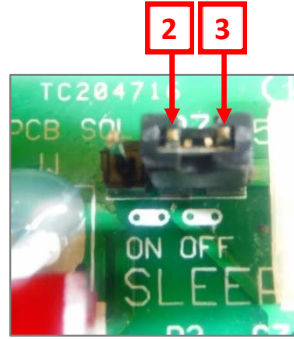
ENERGY SAVING SLEEP MODE	
ON	OFF
PCB Jumper JP7 (Pin Numbers 1 and 2) 	PCB Jumper JP7 (Pin Numbers 2 and 3) 

PROGRAMMING “CHANGING HOT WATER MODE TO AMBIENT WATER”

The **WL100 Water Treatment System** comes with set to Hot / Cold, which can be changed to Ambient / Cold settings. On the Energy Saver PCB, move the Jumper on JP9 from Pins 1 and 2 to Pins 2 and 3.

Unplug Power Cord and remove Top Cover to access Energy Saver PCB.

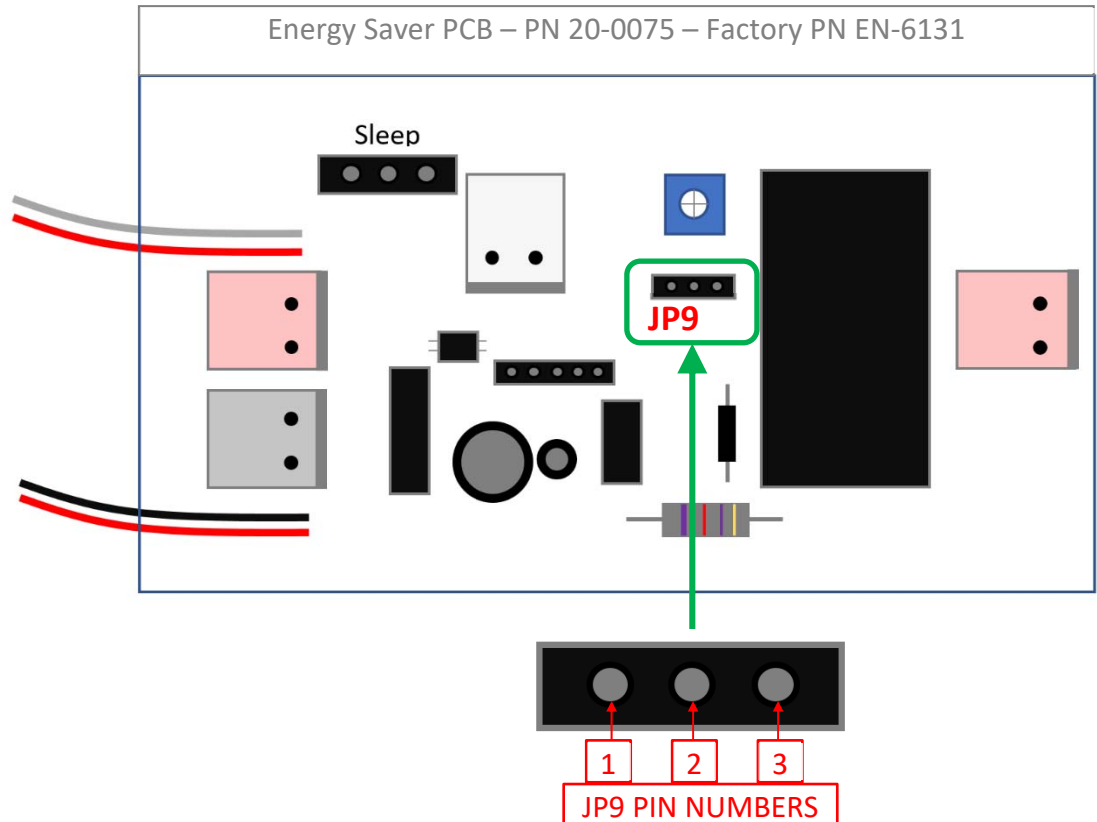

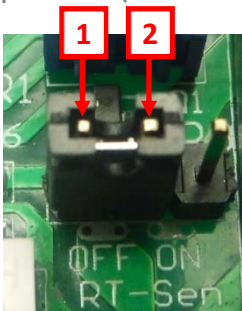
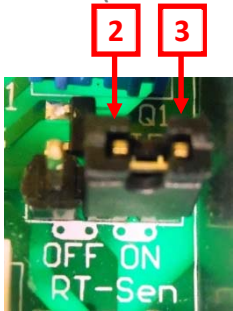
Hot and Cold (Factory Settings)	Ambient and Cold
PCB Jumper JP9 (Pin Numbers 1 and 2) 	PCB Jumper JP9 (Pin Numbers 2 and 3) 

REPLACEMENT COMPONENTS (CONSUMABLES)

Component	WLCP Part No.	Frequency of Replacement
Hot Tank Factory Setting - 85°C (185°F)	12-5615	Replace every 3 to 5 years depending on usage. Factory Part No HT-3041
GAC Filter - 10" Carbon Activated Inline Filter - <i>Optional</i>	FT-0035-IL-WTL	Every 6-months or as required. Filter Element PN FT-0038-WLT
Carbon Filter 1-micron 10" Inline CBC Filter Assembly <i>Optional</i>	FT-0034-IL-WLT	Every 6-months or as required. Filter Element PN FT-0036-WLT

Replacement parts can be obtained from *Waterlogic* or an *Authorized Waterlogic Dealer*. See *Parts Layouts, Drawings, and Lists* for additional repair parts.

Hot Tank Service

Hot Tanks (with controls) must be replaced at least every 3-5 years depending on usage. Descaling Hot Tank may be required on a regular basis depending upon filtration and local water conditions. See Hot Tank Descaling Instructions Section of this manual.

Surface Cleaning

Clean on a regular basis with damp lint free cloth. Never use harsh chemicals (alcohol or acid based) or abrasive agents on any part of the product to avoid damage. A mild cleaner such as Simple green or equivalent is recommended.

DISPOSAL

End of Life

At the **end of this product's life**, ensure that it is disposed of in an environmentally friendly manner which is fully compliant **with all Federal/State/Local Requirements and Guidelines**. Do not dispose of this appliance with normal household or business waste.

WL100 COUNTER TOP DRAWINGS AND PARTS LIST

Yellow = Consumables

Green = Recommended spare parts

Wetted Parts

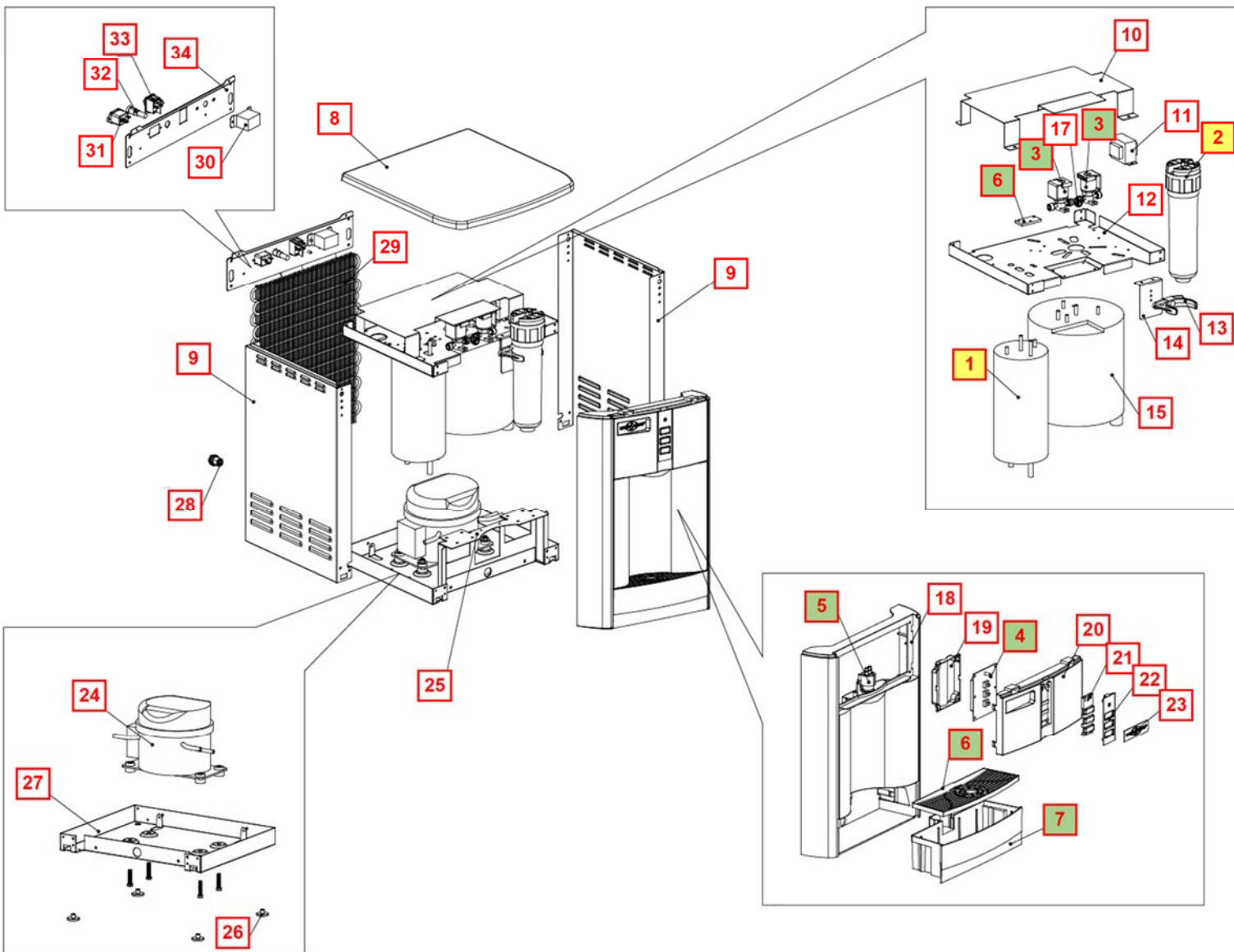
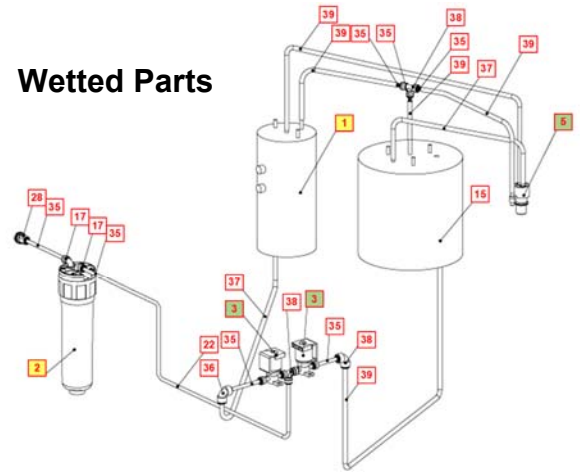





No	WLCP Part No.	Description	Part No	Stocked?	
Consumables					
1	12-5615	Hot Tank 1.6 Liter 100V / 500W Factory Set Point 85°C (185°F)	HT-3041	Yes	
2.1	FT-0035	GAC Filter - 10" Carbon Activated Inline Filter Assembly - Optional GAC Replacement Filter Element PN: FT-0038-WLT	FT-0035-IL-WLT	Yes	
2.2	FT-0053	10" Sediment Filter Assembly - Optional Sediment Replacement Filter Element PN: FT-0055-WLT	FT-0053-IL-WLT	Yes	
2.3	FT-0063	10" CBC Filter Assembly - (Cyst, Lead, Asbestos Reduction) - Optional CBC Replacement Filter Element PN: FT-0064-WLT	FT-0063-IL-WLT	Yes	
Recommended Spare Parts					
1.1	12-6900	Thermostat and Overload Metal Cover <i>Recommend stocking 2 each for every 10 units purchased</i>	ST-8290	Yes	
1.2	EL-0159	Overload with Manual Reset - 97°C (207°F) <i>Recommend stocking 2 each for every 10 units purchased</i>	EL-0159-L00-00	Yes	
1.3	12-1303	Hot Tank Thermostat - 85°C (185°F) <i>Recommend stocking 2 each for every 10 units purchased</i>	HT-3013A	Yes	
3	12-5665	Solenoid Valve with Terminal at Outlet Position <i>Recommend stocking 5 each for every 10 units purchased</i>	PU-4164-L00-00	Yes	
3.1	CU-0001	Solenoid Cushion <i>Recommend stocking 5 each for every 10 units purchased</i>	CU-0001	Yes	
4	20-0040	Display PCB <i>Recommend stocking 2 each for every 10 units purchased</i>	EN-6130	Yes	
5	10-2700	Faucet Assembly <i>Recommend stocking 2 each for every 10 units purchased</i>	PL-1011	Yes	

5.1	10-2600	Natural Faucet O-Ring – Silicon White <i>Recommend stocking 2 each for every 10 units purchased</i>	CT-2007	Yes	
5.2	10-3048	Faucet Nipple – Blue with Screen <i>Recommend stocking 2 each for every 10 units purchased</i>	PL-1013	Yes	
6	20-1040	Drip Tray Grill Charcoal <i>Recommend stocking 5 each for every 10 units purchased</i>	PL-1362-L00-CL	Yes	
	20-0065	Drip Tray Grill – Blue <i>Recommend stocking 5 each for every 10 units purchased</i>	PL-1362	Yes	
7	20-1035	Drip Tray Body – Charcoal No Logo <i>Recommend stocking 5 each for every 10 units purchased</i>	PL-1361-L00-CL	Yes	
	20-0070	Drip Tray Body – Blue No Logo <i>Recommend stocking 5 each for every 10 units purchased</i>	PL-1361	Yes	
Remainder of Parts					
8	20-1045	Top Cover Flat - Charcoal Textured	PL-1366-L00-CL	Yes	
	20-0005	Top Cover Flat – Blue	PL-1366	Yes	
9	12-5675	Side Panel – Counter Top only	ST-8148-A	Yes	
10	12-6900	High Voltage Cover Counter Top Only	ST-8301	Yes	
11	12-1200	Power Transformer 120V / 60Hz	EL-5021	Yes	
12	12-3165	Upper Shelf Counter Top Only	ST-8150-B	Yes	

13	20-1010	2.8" Filter Clip for In-Line Filter	PU-4161	Q	
14	20-1015	Filter Bracket Counter Top Only	ST-8326	Yes	
15	NA	2 Liter Cold Tank Countertop Only	CT-2087-A	Special Order	
16	20-0075	Energy Saver PCB	EN-6131	Yes	
16.1	20-1005	Jumper Pin	EN-6082	Yes	
17	NA	1/4" Union Elbow John Guest P/N P10308S	PU-4008	Purchase from John Guest	
18	20-0030	Front Upper Drip Tray Insert Panel - when purchasing, also request Hot Water Caution Label LP-7169 / 12-0001 to adhere to front of this Panel.	PL-1365	Yes	
18.1	12-0001	Hot Water Caution Label – Adhere to Front Upper Drip Tray Insert Panel.	LP-7169	Yes	
19	20-0035	Front PCB Cover	PL-1369	Yes	
20	20-1050	Front Upper Insert Panel - Charcoal	PL-1367-L00-CL-BIO	Yes	
	20-0045	Front upper Insert Panel – Blue	PL-1367	Yes	
21	20-0050	Silicon Button Keymat	PL-1370	Yes	





22	20-0055	Button PCB Insert Panel - Silver	PL-1368	Yes	
23	20-1030	WL100 Label – Front Upper Insert Panel - Charcoal	LP-0269-L00-00	Yes	
	20-0060	WL100 Label – Front Upper Insert Panel – Blue	LP-7292	Yes	
24	NA	Compressor 120V / 60Hz	CO-9045	Special Order	
24.1	12-1001	Filter Dryer	CO-9008	Yes	
24.2	10-3003	Compressor Starter Relay	CO-9016	Yes	
24.3	10-5018	Compressor Overload	CO-9015	Yes	
25	12-3175	Filter Bracket Counter Top Only	ST-8152-B	Yes	
26	12-3150	Unit Rubber Feet – Counter Top Only	PL-1251-CN	Yes	
27	12-3170	Bottom Panel Counter Top Only	ST-8151-A	Yes	
28	10-3067	Bulkhead Union ¼" x ¼" John Guest P/N PI1208S	PU-4028	Yes	
29	12-3100	Wire Condenser Counter Top Only	CO-9031	Special Order	
30	19-1069	Cold Tank Thermostat	CT-2070-A	Yes	
30.1	LP-0326	Cold Adjustment Cover Label	LP-0326-L00-00	Yes	

31	19-1090	Socket for Plug Connection	EL-0061-L00-00	Yes	
31.1	19-1015	Gasket for Power Socket	ST-8052	Yes	
32	10-3014	Fuse Holder and Fuse 120V / 15A with One Wire	EL-5053	Yes	
32.1	10-3013	Fuse 120V / 15A	EL-5010	Yes	
33	12-5600	Red Heater and Compressor Switch	EL-5019-A	Yes	
34	12-5674	Back Panel – Silver Countertop Only	ST-8253	No	
35	NA	JG LLD PE Tube - Blue O.D.1/4" John Guest P/N PE-08-BI-1000F-B	PU-4031	Purchase from John Guest	
36	NA	5/16" X 1/4" Reducing Elbow John Guest P/N PI211008S	PU-4007	Purchase from John Guest	
37	10-3062	JG LLDPE Tube - Blue 8mm John Guest P/N PE-0806-100M-B	PU-4014-A	Yes	
36	NA	1/4" Union Tee John Guest P/N P10208S	PU-4011-A	Purchase from John Guest	
39	10-7040	Silicon Tube 5/16" for Hot Water	PU-4064	Yes	
Not Shown	10-3007	Power Cord – 120V / 60Hz	EL-5001-B	Yes	

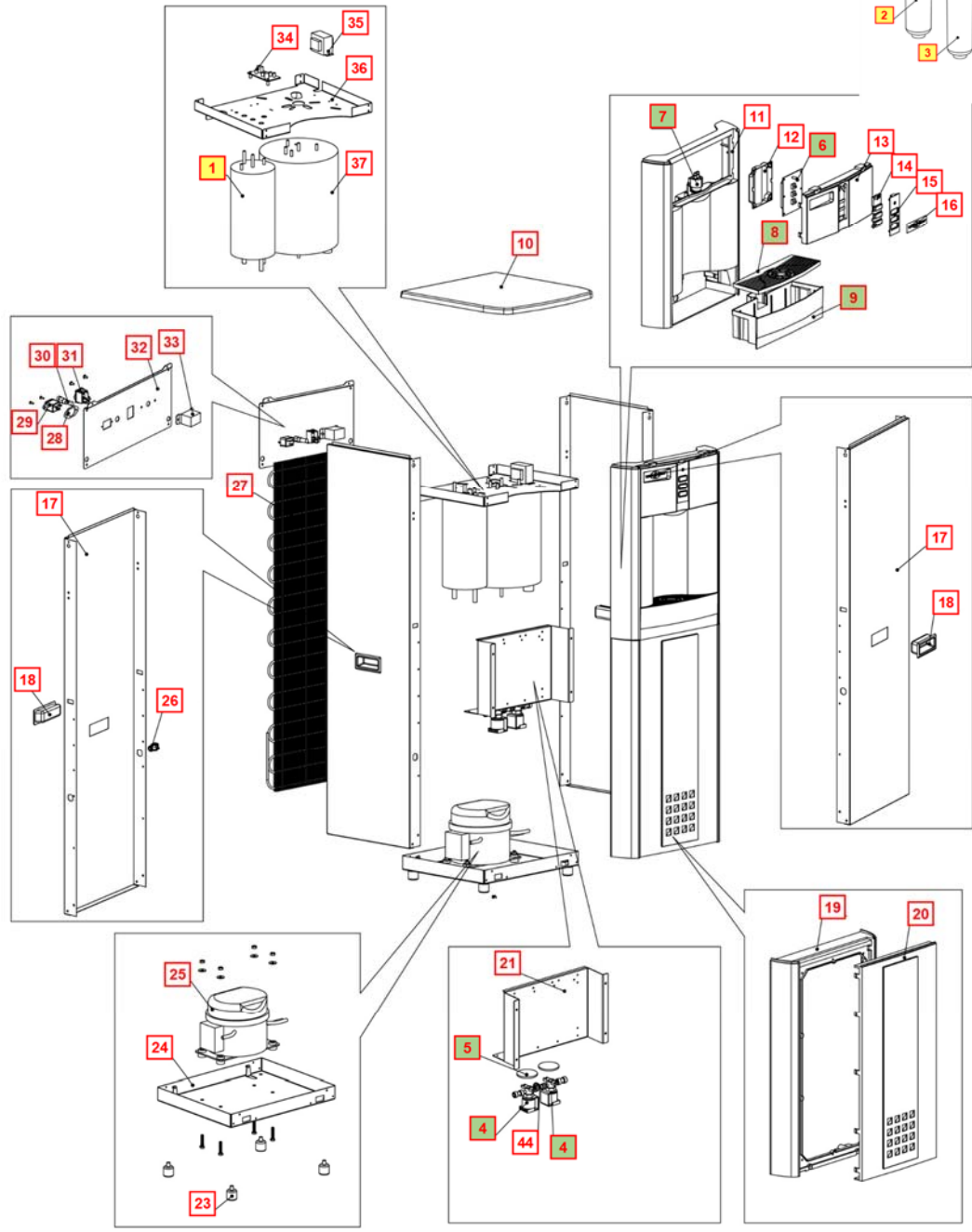
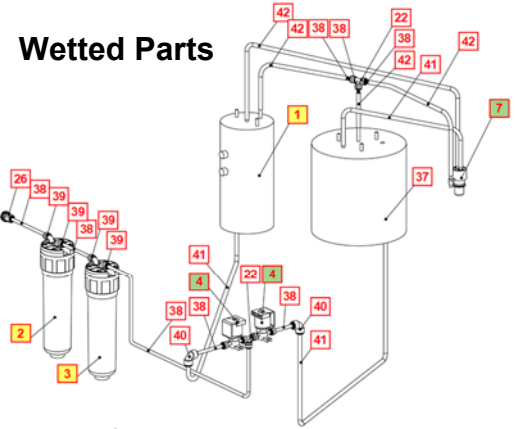
WL100 TOWER DRAWING AND PARTS LIST

Yellow = Consumables
 Green = Recommended spare parts



No	WLCP Part No.	Description	Part No	Stocked?	
Consumables					
1	12-5615	Hot Tank 1.6 Liter 100V / 500W Factory Set Point 85°C (185°F)	HT-3041	Yes	
2.1	FT-0035	GAC Filter - 10" Carbon Activated Inline Filter Assembly - Optional GAC Replacement Filter Element PN: FT-0038-WLT	FT-0035-IL-WLT	Yes	
2.2	FT-0053	10" Sediment Filter Assembly - Optional Sediment Replacement Filter Element PN: FT-0055-WLT	FT-0053-IL-WLT	Yes	
2.3	FT-0063	10" CBC Filter Assembly - (Cyst, Lead, Asbestos Reduction) - Optional CBC Replacement Filter Element PN: FT-0064-WLT	FT-0063-IL-WLT	Yes	
Recommended Spare Parts					
1.1	12-6900	Thermostat and Overload Metal Cover <i>Recommend stocking 2 each for every 10 units purchased</i>	ST-8290	Yes	
1.2	EL-0159	Overload with Manual Reset - 97°C (207°F) <i>Recommend stocking 2 each for every 10 units purchased</i>	EL-0159-L00-00	Yes	
1.3	12-1303	Hot Tank Thermostat - 85°C (185°F) <i>Recommend stocking 2 each for every 10 units purchased</i>	HT-3013A	Yes	
4	12-5665	Solenoid Valve with Terminal at Outlet Position <i>Recommend stocking 5 each for every 10 units purchased</i>	PU-4164-L00-00	Yes	
5	CU-0001	Solenoid Cushion <i>Recommend stocking 5 each for every 10 units purchased</i>	CU-0001	Yes	
6	20-0040	Display PCB <i>Recommend stocking 2 each for every 10 units purchased</i>	EN-6130	Yes	
7	10-2700	Faucet Assembly <i>Recommend stocking 2 each for every 10 units purchased</i>	PL-1011	Yes	

7.1	10-2600	Natural Faucet O-Ring – Silicon White <i>Recommend stocking 2 each for every 10 units purchased</i>	CT-2007	Yes		
7.2	10-3048	Faucet Nipple – Blue with Screen <i>Recommend stocking 2 each for every 10 units purchased</i>	PL-1013	Yes		
8	20-1040	Drip Tray Grill Charcoal <i>Recommend stocking 5 each for every 10 units purchased</i>	PL-1362-L00-00	Yes		
	20-0065	Drip Tray Grill – Blue <i>Recommend stocking 5 each for every 10 units purchased</i>	PL-1362	Yes		
9	20-1035	Drip Tray Body – No Logo <i>Recommend stocking 5 each for every 10 units purchased</i>	PL-1361-L00-CL	Yes		
	20-0070	Drip Tray Body – Blue No Logo <i>Recommend stocking 5 each for every 10 units purchased</i>	PL-1361	Yes		
Remainder of Parts						
10	20-1045	Top Cover Flat - Charcoal Textured	PL-1366-L00-CL	Yes		
	20-0005	Top Cover Flat – Blue	PL-1366	Yes		
11	20-0030	Front Upper Drip Tray Insert Panel - - <i>when purchasing, also request Hot Water Caution Label LP-7169 / 12-0001 to adhere to front of this Panel.</i>	PL-1365	Yes		
11.1	12-0001	Hot Water Caution Label – Adhere to Front Upper Drip Tray Insert Panel.	LP-7169	Yes		
12	20-0035	Front PCB Cover	PL-1369	Yes		
13	20-1050	Front Upper Insert Panel - Charcoal	PL-1367-L00-CL-BIO	Yes		
	20-0045	Front upper Insert Panel – Blue	PL-1367	Yes		

14	20-0050	Silicon Button Key mat	PL-1370	Yes	
15	20-0055	Button PCB Insert Panel - Silver	PL-1368	Yes	
16	20-1030	WL100 Label – Front Upper Insert Panel - Charcoal	LP-0269-L00-00	Yes	
	20-0060	WL100 Label – Front Upper Insert Panel - Blue	LP-7292-A	Yes	
17	20-0010	Side Panel - Tower Only	ST-8249-A	Yes	
18	12-8058	Side Panel Plastic Handle - Tower Only	PL-1123	Yes	
19	20-0025	Front Lower Panel Tower Only	PL-1364	Yes	
20	20-1055	Front Lower Insert Panel - Charcoal Tower Only	PL-1363-L00-CL	Yes	
	20-0020	Front Lower Insert Panel - Blue Tower Only	PL-1363	Yes	
21	20-0015	Filter Fixing Bracket - Tower Only	ST-8138-B	Yes	
22	NA	¼" Equal Tee Connector John Guest P/N P10208S	PU-4011	Purchase from John Guest	
23	10-3083	Unit Control Rubber Feet - Tower Only	ST-8167-CN	Yes	
24	20-0015	Bottom Tray- Tower Only	ST-8137-A	Yes	

25	NA	Compressor 120V / 60Hz	CO-9045	Special Order	
25.1	12-1001	Filter Dryer	CO-9008	Yes	
25.2	10-3003	Compressor Starter Relay	CO-9016	Yes	
25.3	10-5018	Compressor Overload	CO-9015	Yes	
26	10-3067	Bulkhead Union ¼" x ¼" John Guest P/N PI1208S	PU-4028-A	Yes	
27	12-8102	Wire Condenser - Tower Only	CO-9027	Special Order	
28	19-1015	Gasket for Power Socket	ST-8052	Yes	
29	TBD	Socket for Plug Connection	EL-0061-L00-00	Yes	
30	10-3014	Fuse Holder and Fuse 120V / 15A with One Wire	EL-5053	Yes	
30.1	10-3013	Fuse 120V / 15A	EL-5010	Yes	
31	12-5600	Red Heater and Compressor Switch	EL-5019-A	Yes	
32	12-5673	Back Panel Tower Only	ST-8135-A	No	
33	19-1069	Cold Tank Thermostat	CT-2070-A	Yes	
33.1	LP-0326	Cold Adjustment Cover Label	LP-0326-L00-00	Yes	
34	20-0075	Energy Saver PCB	EN-6131	Yes	
34.1	20-1005	Jumper Pin	EN-6082	Yes	

34.2	10-3017	Plastic PCB Support	EN-6059	Yes	
35	12-1200	Power Transformer 120V / 60Hz	EL-5021	Yes	
36	12-8003	Upper Shelf - Tower Only	ST-8136-A	Yes	
37	NA	2 Liter (0.5 Gallon) Cold Tank Tower Only	CT-2087	Special Order	
38	NA	JG LLD PE Tube - Blue O.D.1/4" John Guest P/N PE-08-BI-1000F-B	PU-4031	Purchase from John Guest	
39	NA	1/4" Equal Elbow Connector John Guest P/N P10308S	PU-4008	Purchase from John Guest	
40	Purchase from John Guest	5/16" X 1/4" Reducing Elbow John Guest P/N PI211008S	PU-4007-A	No	
41	10-3062	JG LLDPE Tube - Blue 8mm (PE-0806- 100M-B)	PU-4014	Yes	
42	10-7040	Silicon Tube 5/16" for Hot Water	PU-4064-L00- 00	Yes	
Not shown	10-3099	2 1/2" Filter Clip - Tower Only	PU-4024	Yes	
Not shown	10-3098	2" Filter Clip for In-Line Filter	PU-4025	Yes	
Not Shown	10-3007	Power Cord – 120V	EL-5001-B	Yes	

WL100 WATER FLOW DIAGRAM

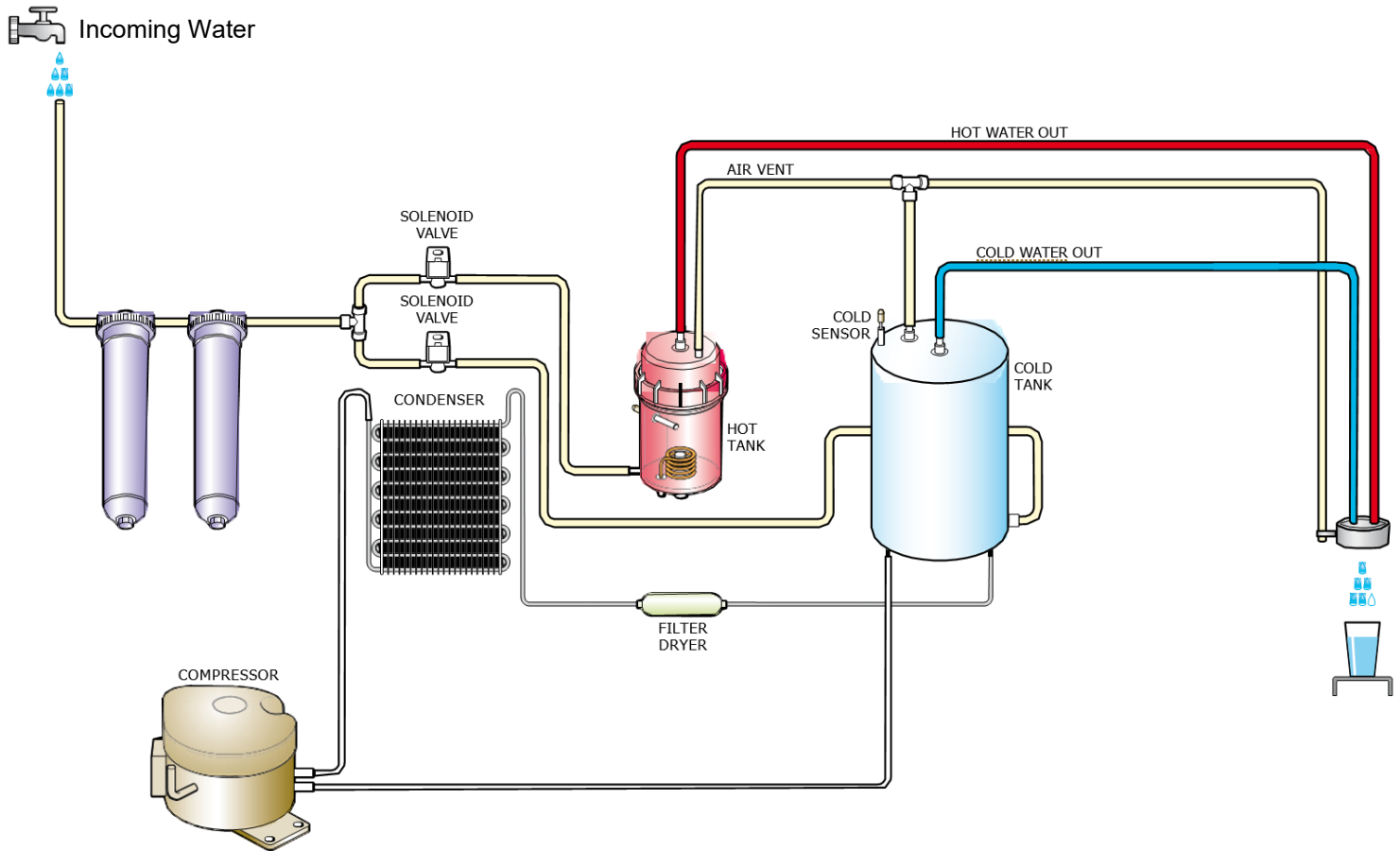

WL100 ELECTRICAL DIAGRAM

⚠ DANGER! HIGH VOLTAGE ELECTRICAL HAZARD. PCB (Printed Circuit Board) contains High Voltage. Only trained and qualified technicians should attempt live testing.

